

PRODUCT SPECIFICATIONS

LEAD FREE CAST BRASS FITTINGS

CLASS 125 lbs.



Lead Free products contain less than .25% weighted average lead content on wetted surfaces.

MATCO
NORCATM

www.matco-norca.com

LEAD FREE BRASS COMPOSITION & APPROVALS

Lead Free Brass Composition:

	Copper	Tin	Lead	Zinc
Min.	87.00%	4.00%	0.00%	2.00%
Max.	91.00%	6.00%	0.10%	4.00%
	Iron	Nickel	Antimony	Phosphorus
Min.	0.00%	0.00%	0.00%	0.00%
Max.	0.30%	1.00%	0.25%	0.05%
	Sulfur	Aluminum	Silicon	Bismuth
Min.	0.00%	0.00%	0.00%	1.70%
Max.	0.08%	0.005%	0.005%	2.70%

Lead Free Brass Approvals:

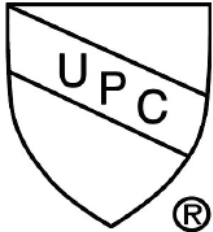

* These product complies with 0.25% weighted average lead content on wetted surfaces in accordance with CA AB1953.

PRODUCT SPECIFICATIONS

Lead Free Brass Elbow 90

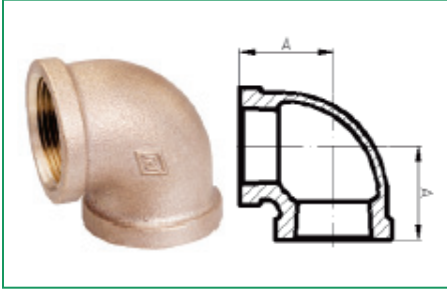

Size	1/8"	1/4"	3/8"	1/2"	3/4"	1"
A	0.54	0.71	0.82	1.01	1.18	1.43

Size	1-1/4"	1-1/2"	2"	2-1/2"	3"	4"
A	1.69	1.84	2.12	2.70	3.08	3.79

Lead Free Brass Elbow 45

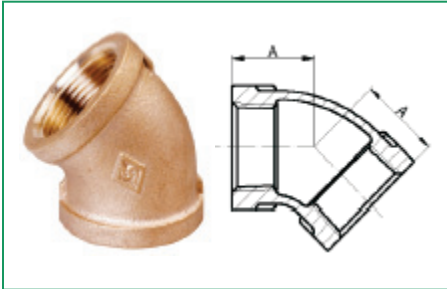

Size	1/8"	1/4"	3/8"	1/2"	3/4"	1"
A	0.42	0.56	0.63	0.78	0.89	1.06

Size	1-1/4"	1-1/2"	2"	2-1/2"	3"	4"
A	1.22	1.30	1.45	1.95	2.17	2.61

Lead Free Brass Street Elbow 90

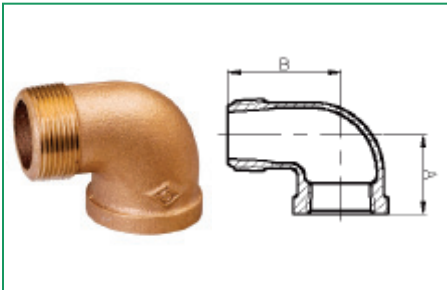

Size	1/8"	1/4"	3/8"	1/2"	3/4"	1"
A	0.54	0.71	0.82	1.01	1.18	1.43
B	0.92	1.11	1.24	1.48	1.65	1.98

Size	1-1/4"	1-1/2"	2"	2-1/2"	3"
A	1.69	1.84	2.12	2.72	3.08
B	2.24	2.46	2.88	3.86	4.52

Lead Free Brass Street Elbow 45

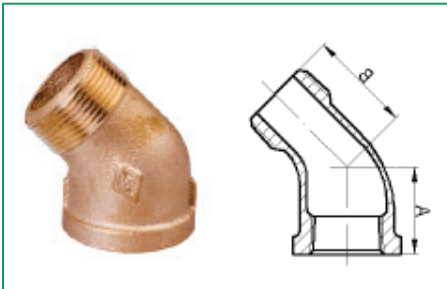

Size	1/8"	1/4"	3/8"	1/2"	3/4"	1"
A	0.42	0.56	0.63	0.78	0.89	1.06
B	0.78	0.88	0.92	1.06	1.23	1.40

Size	1-1/4"	1-1/2"	2"
A	1.22	1.30	1.45
B	1.64	1.80	2.14

* These product complies with 0.25% weighted average lead content on wetted surfaces in accordance with CA AB1953.

PRODUCT SPECIFICATIONS

Lead Free Brass Reducing Elbow

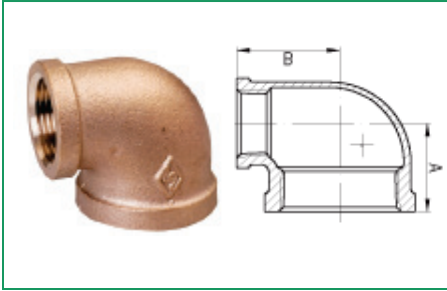

Size	3/8"x1/4"	1/2"x1/4"	1/2"x3/8"	3/4"x1/8"	3/4"x1/4"
A	0.75	0.95	0.96	1.02	1.04
B	0.79	0.95	0.90	1.06	1.06
Size	3/4"x3/8"	3/4"x1/2"	1"x1/2"	1"x3/4"	1-1/4"x1/2"
A	1.12	1.08	1.20	1.30	1.34
B	1.12	1.11	1.24	1.31	1.52
Size	1-1/4"x3/4"	1-1/4"x1"	1-1/2"x1/2"	1-1/2"x3/4"	1-1/2"x1"
A	1.40	1.52	1.26	1.50	1.52
B	1.58	1.60	1.50	1.73	1.69
Size	2"x1"	2"x1-1/2"	2-1/2"x2"		
A	1.71	1.89	2.39		
B	2.01	2.07	2.60		

Lead Free Brass Cross

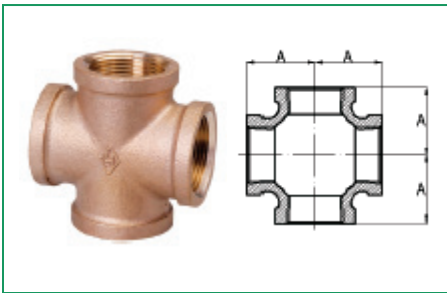

Size	1/8"	1/4"	3/8"	1/2"	3/4"	1"
A	0.54	0.71	0.82	1.01	1.18	1.43
Size	1-1/4"	1-1/2"	2"			
A	1.69	1.84	2.12			

Lead Free Brass Union

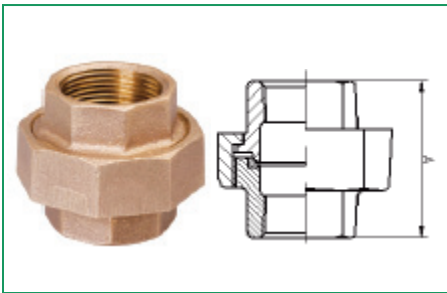

Size	1/8"	1/4"	3/8"	1/2"	3/4"	1"
A	1.26	1.46	1.62	1.73	1.95	2.07
Size	1-1/4"	1-1/2"	2"	2-1/2"	3"	4"
A	2.27	2.42	2.76	3.23	3.51	3.86

Lead Free Brass Cap

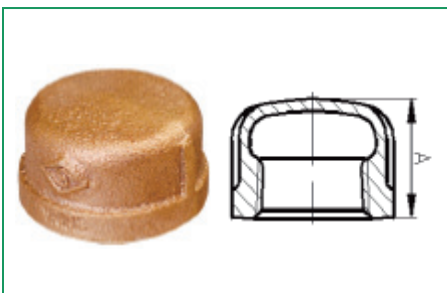

Size	1/8"	1/4"	3/8"	1/2"	3/4"	1"
A	0.49	0.59	0.65	0.76	0.84	0.99
Size	1-1/4"	1-1/2"	2"	2-1/2"	3"	4"
A	1.10	1.15	1.32	1.70	1.80	2.08

* These product complies with 0.25% weighted average lead content on wetted surfaces in accordance with CA AB1953.

PRODUCT SPECIFICATIONS

Lead Free Brass Tees

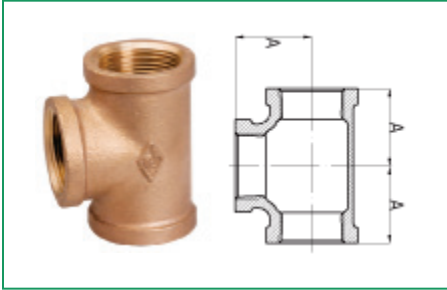

Size	1/8"	1/4"	3/8"	1/2"	3/4"	1"
A	0.54	0.71	0.82	1.01	1.18	1.43

Size	1-1/4"	1-1/2"	2"	2-1/2"	3"	4"
A	1.69	1.84	2.12	2.70	3.08	3.79

Lead Free Brass Reducing Tees

Two Sizes

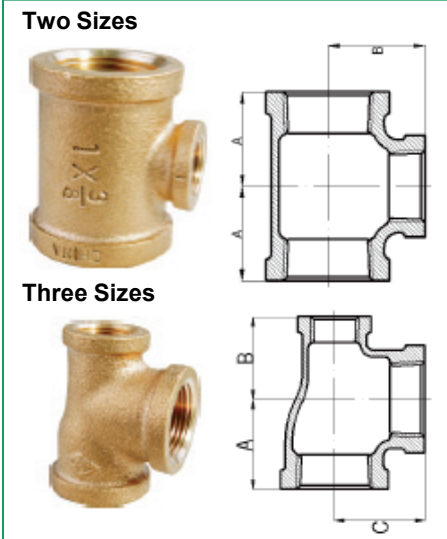

Three Sizes

Two Sizes

Size	3/8"x1/4"	1/2"x1/4"	1/2"x3/8"	3/4"x1/4"
A	0.87	0.85	0.93	1.04
B	0.89	0.87	0.90	1.06

Size	3/4"x3/8"	3/4"x1/2"	1"x1/4"	1"x1/2"
A	1.08	1.08	1.02	1.20
B	1.10	1.11	1.14	1.24

Size	1"x3/4"	1-1/4"x1/2"	1-1/4"x3/4"	1-1/4"x1"
A	1.30	1.29	1.39	1.52
B	1.31	1.41	1.48	1.60

Size	1-1/2"x1/2"	1-1/2"x3/4"	1-1/2"x1"	1-1/2"x1-1/4"
A	1.32	1.42	1.55	1.72
B	1.53	1.60	1.72	1.81

Size	2"x1/2"	2"x3/4"	2"x1"	2"x1-1/4"
A	1.44	1.47	1.59	1.73
B	1.83	1.81	1.95	2.01

Size	2"x1-1/2"	2-1/2"x1-1/4"	2-1/2"x2"	3"x2"
A	1.89	2.01	2.38	2.52
B	2.07	2.44	2.60	2.89

Three Sizes

Size	1/2"x1/2"x3/4"	3/4"x1/2"x1/2"	3/4"x1/2"x3/4"	3/4"x3/4"x1"	1"x1/2"x1/2"
A	1.11	1.08	1.18	1.25	1.26
B	1.11	1.01	1.11	1.26	1.40
C	1.08	1.11	1.18	1.28	1.10

Size	1"x1/2"x3/4"	1"x1/2"x1"	1"x3/4"x3/4"	1"x3/4"x1"	1-1/4"x1/2"x1-1/4"
A	1.36	1.43	1.30	1.43	1.64
B	1.44	1.24	1.18	1.31	1.64
C	1.24	1.43	1.31	1.43	1.36

Size	1-1/4"x3/4"x1-1/4"	1-1/4"x1"x1-1/4"	1-1/2"x1/2"x1-1/2"	1-1/2"x1-1/4"x1-1/4"
A	1.64	1.64	1.93	1.66
B	1.64	1.64	1.93	1.76
C	1.44	1.52	1.65	1.64

* These product complies with 0.25% weighted average lead content on wetted surfaces in accordance with CA AB1953.

PRODUCT SPECIFICATIONS

Lead Free Brass Couplings

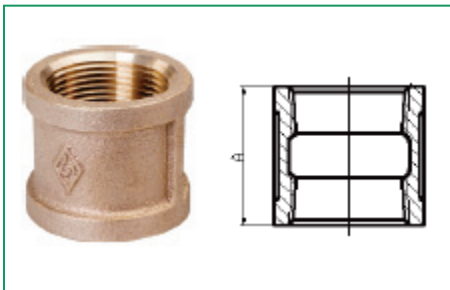

Size	1/8"	1/4"	3/8"	1/2"	3/4"	1"
A	0.80	0.97	1.05	1.29	1.43	1.68
Size	1-1/4"	1-1/2"	2	2-1/2"	3"	4"
A	1.86	1.92	2.20	2.88	3.18	3.69

Lead Free Brass Reducing Couplings

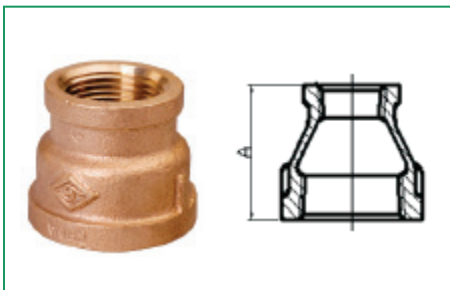

Size	1/4"x1/8"	3/8"x1/8"	3/8"x1/4"	1/2"x1/8"
A	0.88	1.01	1.01	1.13
Size	1/2"x1/4"	1/2"x3/8"	3/4"x1/4"	3/4"x3/8"
A	1.13	1.17	1.24	1.24
Size	3/4"x1/2"	1"x3/8"	1"x1/2"	1"x3/4"
A	1.36	1.49	1.49	1.56
Size	1-1/4"x1/2"	1-1/4"x3/4"	1-1/4"x1"	1-1/2"x1/2"
A	1.65	1.65	1.77	1.80
Size	1-1/2"x3/4"	1-1/2"x1"	1-1/2"x1-1/4"	2"x1/2"
A	1.80	1.80	1.89	2.03
Size	2"x3/4"	2"x1"	2"x1-1/4"	2"x1-1/2"
A	2.03	2.03	2.03	2.06
Size	2-1/2"x1"	2"x1-1/2"	2-1/2"x1-1/4"	2-1/2"x1-1/2"
A	3.25	2.06	3.25	3.25
Size	2-1/2"x2"	3"x2"	3"x2"	3"x2-1/2"
A	3.25	3.69	3.69	3.66
Size	4" x2"	4"x3"		
A	4.29	4.37		

* These product complies with 0.25% weighted average lead content on wetted surfaces in accordance with CA AB1953.

PRODUCT SPECIFICATIONS

Lead Free Brass Bushings

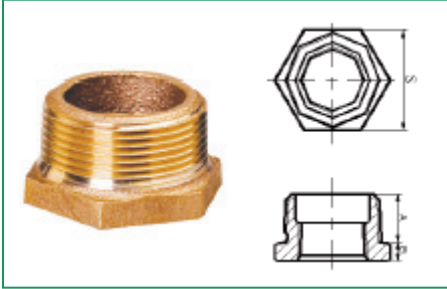

Size	1/4"x1/8"	3/8"x1/8"	3/8"x1/4"	1/2"x1/8"
A	0.44	0.48	0.48	0.56
B	0.14	0.16	0.16	0.19
C	0.64	0.68	0.68	0.87
Size	1/2"x1/4"	1/2"x3/8"	3/4"x1/8"	3/4"x1/4"
A	0.56	0.56	0.63	0.63
B	0.19	0.19	0.22	0.22
C	0.87	0.87	1.15	1.15
Size	3/4"x3/8"	3/4"x1/2"	1"x1/4"	1"x3/8"
A	0.63	0.63	0.75	0.75
B	0.22	0.22	0.30	0.30
C	1.15	1.15	1.12	1.12
Size	1"x1/2"	1"x3/4"	1-1/4"x1/2"	1-1/4"x3/4"
A	0.75	0.75	0.80	0.80
B	0.25	0.25	0.34	0.28
C	1.42	1.42	1.34	1.76
Size	1-1/4"x1"	1-1/2"x1/4"	1-1/2"x3/8"	1-1/2"x1/2"
A	0.80	0.83	0.84	0.83
B	0.28	0.37	0.35	0.37
C	1.76	1.16	1.14	1.34
Size	1-1/2"x3/4"	1-1/2"x1"	1-1/2"x1-1/4"	2"x1/2"
A	0.83	0.83	0.83	0.88
B	0.37	0.31	0.31	0.41
C	1.62	2.00	2.00	1.34
Size	2"x3/4"	2"x1"	2"x1-1/4"	2"x1-1/2"
A	0.88	0.88	0.88	0.88
B	0.41	0.41	0.34	0.34
C	1.63	1.95	2.48	2.48
Size	2-1/2"x1"	2-1/2"x1-1/4"	2-1/2"x1-1/2"	2-1/2"x2"
A	1.07	1.07	1.07	1.07
B	0.44	0.45	0.44	0.37
C	1.95	2.42	2.68	2.98
Size	3"x1-1/2"	3"x2"	3"x2-1/2"	4" x2"
A	1.14	1.13	1.13	1.22
B	0.49	0.48	0.40	0.60
C	2.72	3.28	3.86	3.28
Size	4"x2-1/2"	4"x3"		
A	1.24	1.22		
B	0.61	0.51		
C	3.90	4.63		

* These product complies with 0.25% weighted average lead content on wetted surfaces in accordance with CA AB1953.

PRODUCT SPECIFICATIONS

Lead Free Brass Locknut

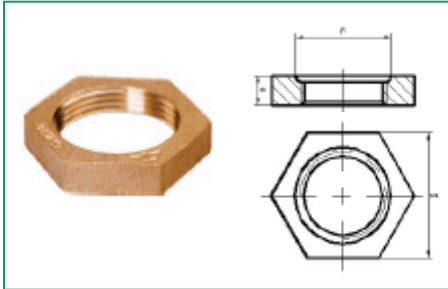

Size	3/8"	1/2"	3/4"	1"	1-1/4"	2"
A	0.19	0.25	0.28	0.31	0.34	0.38
F	0.50	0.66	0.77	0.97	1.23	1.50
S	0.69	0.84	1.00	1.18	1.43	1.75

Lead Free Brass Plug

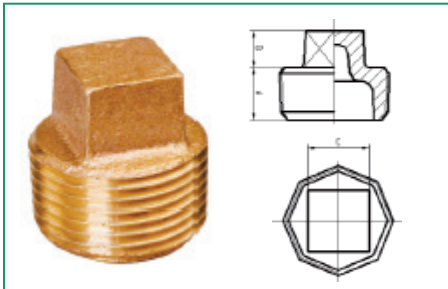

Size	1/8"	1/4"	3/8"	1/2"	3/4"	1"
A	0.27	0.41	0.41	0.54	0.55	0.69
B	0.24	0.28	0.31	0.38	0.44	0.50
C	0.28	0.37	0.43	0.56	0.62	0.81
Size	1-1/4"	1-1/2"	2	2-1/2"	3"	4"
A	0.71	0.73	0.76	1.07	1.13	1.22S
B	0.56	0.62	0.68	0.74	0.80	0.92
C	0.94	1.12	1.31	1.50	1.69	2.25

Lead Free Brass Plug (Solid)

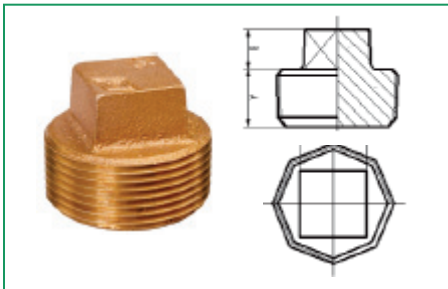

Size	1/2"	3/4"	1"	1-1/4"	1-1/2"	2
A	0.54	0.55	0.69	0.71	0.73	0.76
B	0.38	0.44	0.50	0.56	0.62	0.68
C	0.56	0.62	0.81	0.94	1.12	1.31

Lead Free Brass Countersunk Plug

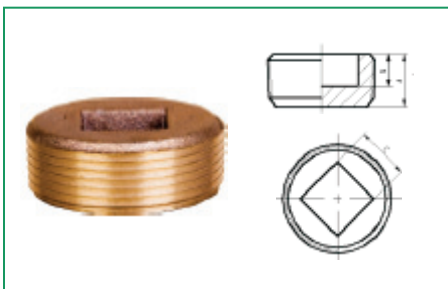

Size	1/2"	3/4"	1"	1-1/4"	1-1/2"	2	3"
A	0.54	0.55	0.69	0.73	0.76	1.13	1.13
B	0.38	0.44	0.50	0.62	0.68	0.80	0.80
C	0.37	0.50	0.50	0.75	0.87	1.38	1.38

* These product complies with 0.25% weighted average lead content on wetted surfaces in accordance with CA AB1953.