

29-1003LKLF Angle Supply Valve • Spec Sheet

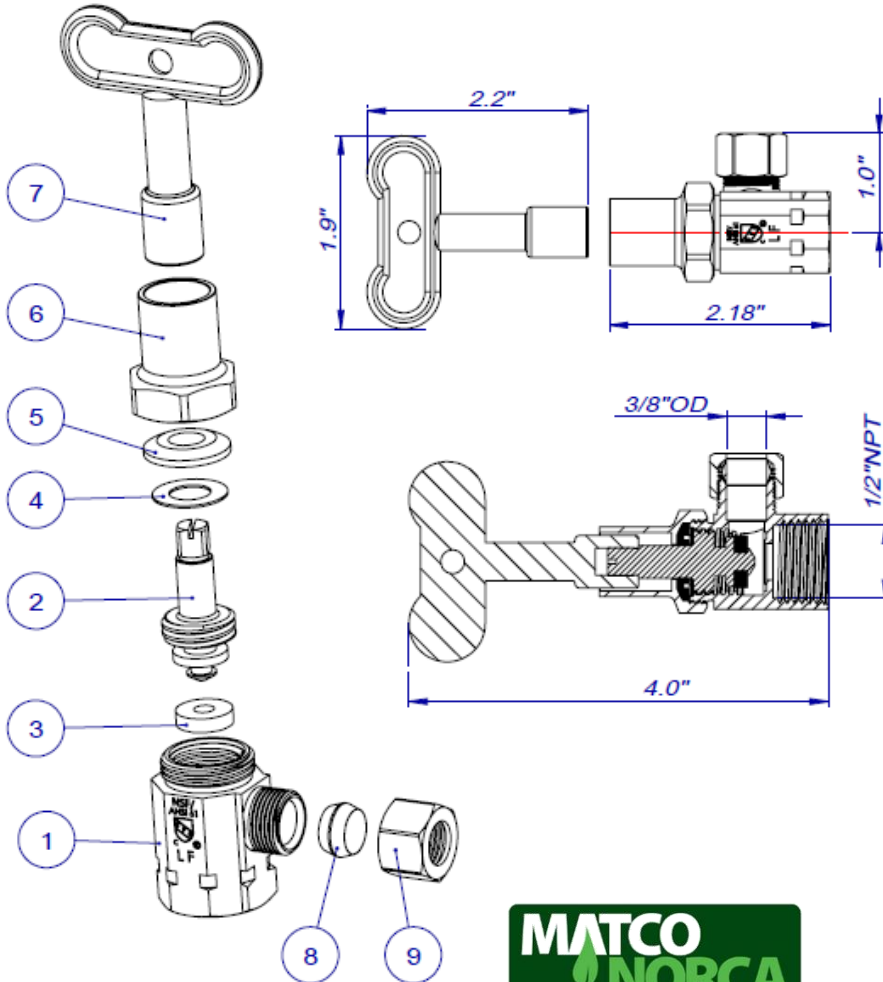

FEATURES & BENEFITS

- Chrome Plated Lead Free Brass*
- Angle
- Multi-Turn
- Loose Key
- cUPC, NSF/ANSI 61 Approval
- 1/2" FIP x 3/8" OD Compression



MATERIAL SPECIFICATIONS

No.	Part	Material
1	Body	LF Brass
2	Stem	LF Brass
3	Washer	NBR
4	Washer	SUS 304
5	Washer	NBR
6	Bonnet	Brass
7	Loose Key	Zinc Alloy
8	Sleeve	LF Brass
9	Hex Cap	Brass

*This product complies with 0.25% weighted average lead content on wetted surfaces in accordance with the Safe Drinking Water Act (SDWA) / Federal Public Law No. 111-380.



Global sourcing. National compliance. Local service.

CALIFORNIA 5595 Fresca Dr., La Palma CA 90623
TEXAS 1150 Silber Rd., Houston TX 77055
ILLINOIS 278 Windy Point Dr., Glendale Heights, IL 60139
GEORGIA 113 Industrial Blvd., Americus, Georgia 31709
NEW YORK PO Box 27, Rt.22, Brewster NY 10509
 WEB: www.matco-norca.com

• Phone: 866-532-8306 • Fax: 866-532-8307
 • Phone: 800-935-5456 • Fax: 713-680-2999
 • Phone: 844-412-5068 • Fax: 800-640-2252
 • Phone: 800-433-7526 • Fax: 800-533-5134
 • Phone: 800-431-2082 • Fax: 845-278-9056
 EMAIL: mail@matco-norca.com