

26-1015PXCELf Angle Supply Valve • Spec Sheet

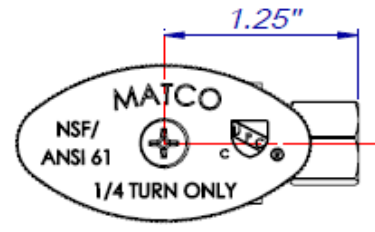

FEATURES & BENEFITS

- Chrome Plated Lead Free Brass*
- Angle
- 1/4 Turn
- Oval Handle
- cUPC, NSF/ANSI 61 Approval
- 1/2" F1960 Cold Expansion PEX x 1/4" OD Compression

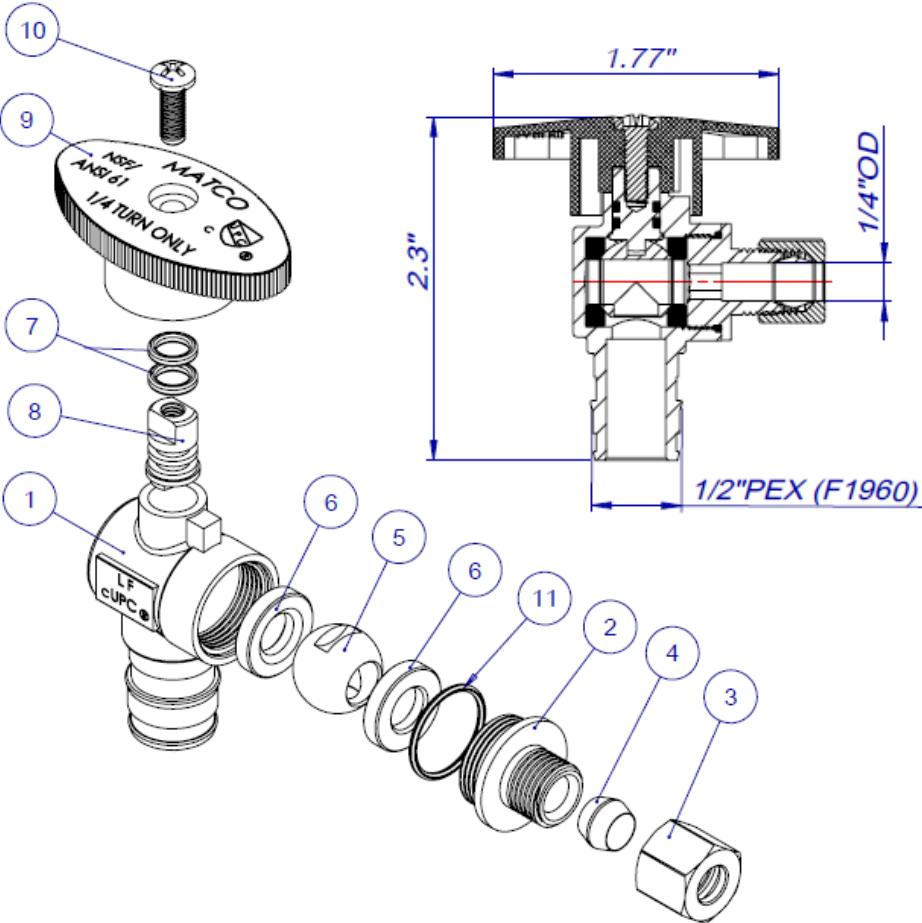

MATERIAL SPECIFICATIONS

No.	Part	Material
1	Body	LF Brass
2	Cap	LF Brass
3	Hex Cap	Brass
4	Sleeve	LF Brass
5	Ball	LF Brass
6	Ring	PTFE
7	O-Ring	NBR
8	Stem	Brass
9	Handle	Plastic
10	Screw	Steel
11	O-Ring	NBR

*This product complies with 0.25% weighted average lead content on wetted surfaces in accordance with the Safe Drinking Water Act (SDWA) / Federal Public Law No. 111-380.



Global sourcing. National compliance. Local service.

CALIFORNIA 5595 Fresca Dr., La Palma CA 90623
TEXAS 1150 Silber Rd., Houston TX 77055
ILLINOIS 278 Windy Point Dr., Glendale Heights, IL 60139
GEORGIA 113 Industrial Blvd., Americus, Georgia 31709
NEW YORK PO Box 27, Rt.22, Brewster NY 10509
 WEB: www.matco-norca.com

• Phone: 866-532-8306 • Fax: 866-532-8307
 • Phone: 800-935-5456 • Fax: 713-680-2999
 • Phone: 844-412-5068 • Fax: 800-640-2252
 • Phone: 800-433-7526 • Fax: 800-533-5134
 • Phone: 800-431-2082 • Fax: 845-278-9056
 EMAIL: mail@matco-norca.com