

200WD Ductile Iron Gate Valve • Spec Sheet

FEATURES & BENEFITS

- Ductile Iron Body
- Resilient Wedge
- 2 Bosses
- Non Rising Stem
- Handwheel or Operating Nut
- 250 CWP
- Fusion Bonded Epoxy Coating AWWA C550
- Meets AWWA C-515 standard
- Flanged Ends Conform with ANSI B16.1
- Sizes: Only available in 2" - 12"

APPLICATIONS

Potable Water, Water Distribution Services & Feed Lines,
Sewage Disposal, Irrigation, Turf, Golf Course

DIMENSIONS

Size	Part # (Handwheel)	Part # (Op Nut)	A	D	D1	n-d1	G	H	W	Approx. WT. LBS
2"	200WD08	200WD08N	7.0	6.0	4.8	4 - .75"	.63	10.00	7.00	28
2-1/2"	200WD09	200WD09N	7.5	7.0	5.5	4 - .75"	.69	11.00	7.87	42
3"	200WD10	200WD10N	8.0	7.5	6.0	4 - .75"	.75	12.80	7.87	44
4"	200WD11	200WD11N	9.0	9.0	7.5	8 - .75"	.94	13.23	9.45	69
6"	200WD13	200WD13N	10.5	11.00	9.5	8 - .88"	1.00	16.75	12.60	119
8"	200WD14	200WD14N	11.5	13.5	11.8	8 - .88"	1.13	20.68	14.17	203
10"	200WD15	200WD15N	13.0	16.0	14.5	12 - 1.00"	1.19	24.61	15.75	278
12"	200WD16	200WD16N	14.0	19.0	17.0	12 - 1.00"	1.26	27.56	15.75	421

W - Handwheel Diameter

MATERIAL SPECIFICATIONS

No.	Part	Material	ASTM Designation
1	Body	Ductile Iron	A536 65/45/12
2	Disc	Ductile Iron Rubber Encapsulated	A536 65/45/12 / BUNA-N
3	Stem Nut	Bronze	B584 UNS C83600
4	Stem	Stainless Steel	AISI 410 UNS S41000
5	Bonnet Bolt	Stainless Steel	GR 304
6	Bonnet Gasket	BUNA-N	Commercial
7	Bonnet	Ductile Iron	A536 65/45/12
8	Split Ring	Brass	B16 UNS C36000
9	Thrust Washer	Stainless Steel	GR 304
10	Packing Box Bolt	Stainless Steel	GR 304
11	Packing Box Gasket	BUNA-N	Commercial
12	O-Rings	BUNA-N	Commercial
13	Packing Box	Ductile Iron	A536 65/45/12
14	Operating Nut	Ductile Iron	A536 65/45/12
15	Top Bolt	Stainless Steel	GR 304
16	Washer	Stainless Steel	AISI 410 UNS S41000
17	Wiper Ring	BUNA-N	Commercial

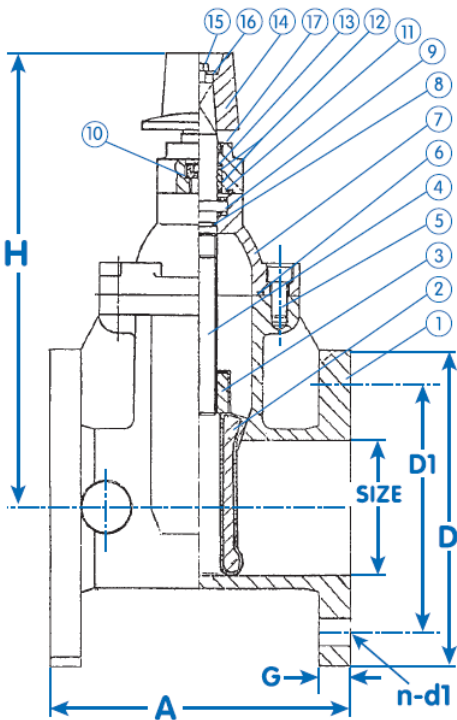

Enlarged Drawing On Page 2
(Click Here)



200WD Ductile Iron Gate Valve • Spec Sheet

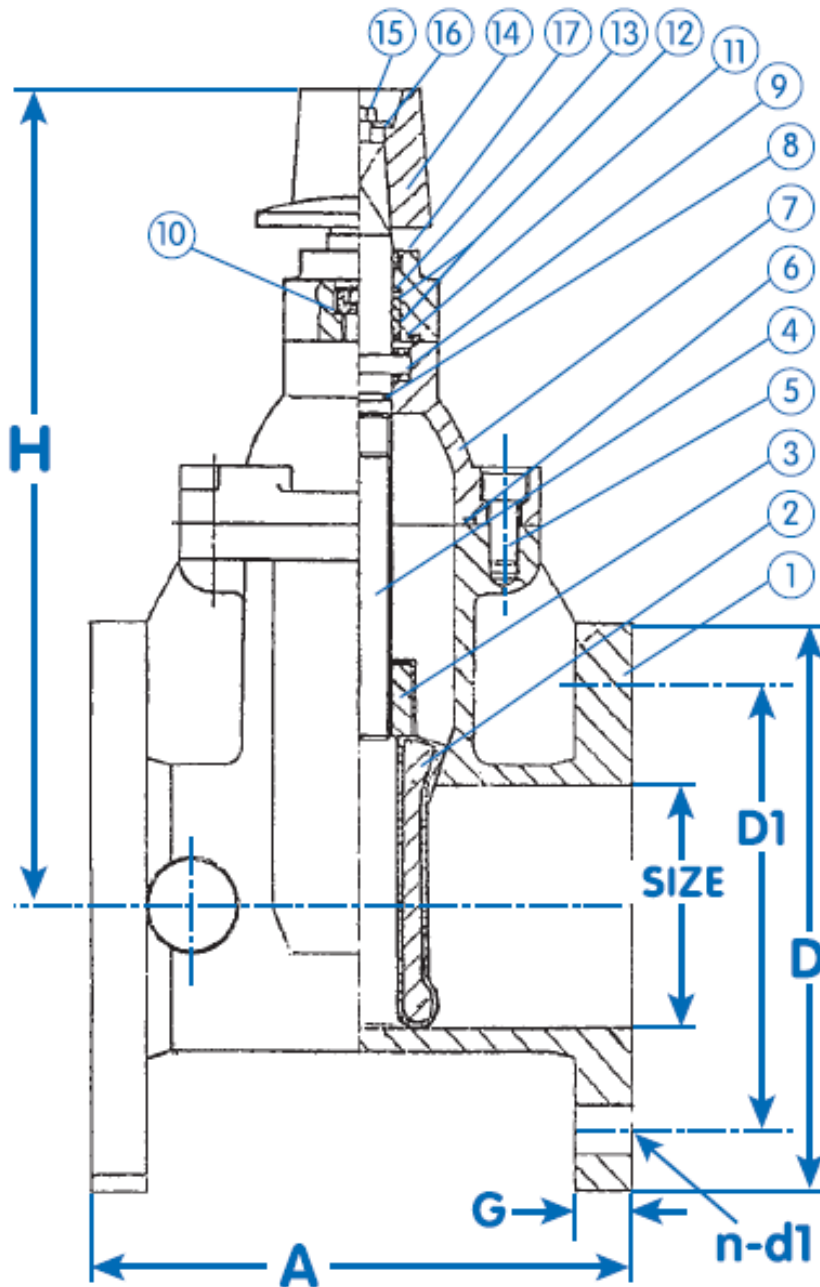

[Return To Page 1 \(Click Here\)](#)



Valve Closure Wheel Rotation Specification for 200MD, WD & RTD Series Gate Valves

The following table notes how many Stem/Wheel rotations are required to completely open or close the 200MD/WD&RTD Series Valves.

Valve Size	Turns to Shut Off
2"	7
2-1/2"	9
3"	10
4"	13
6"	15
8"	17
10"	21
12"	25

