

150# Malleable Fittings

Specification Sheet

CHINA



- Black & Galvanized
- Material: ASTM A197/A197M
- Dimensions:
 - ASME B16.3 covering 90° Elbows, 45° Elbows, Couplings, Reducers, 90° Street Elbows, 45° Street Elbows, Caps, Tees
 - ASME B16.39 covering Unions
 - ASME B16.14 covering Bushings, Plugs
- Threads: ASME B1.201
- Available: 1/8" through 6"
- Approvals: UL & FM approved

MATCO
NORCATM

www.matco-norca.com • mail@matco-norca.com

CHINA

150# Malleable Fittings

Specification Sheet

90 Elbow

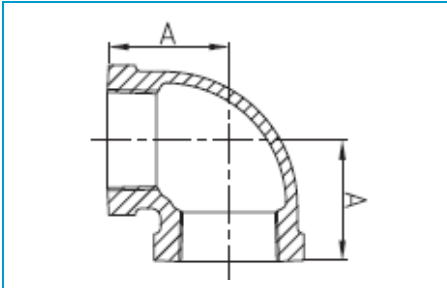

Size	1/8	1/4	3/8	1/2	3/4	1
A	0.69	0.81	0.95	1.12	1.31	1.50
Size	1-1/4	1-1/2	2	2-1/2	3	4
A	1.75	1.94	2.25	2.70	3.08	3.79
Size	5	6				
A	4.50	5.13				

45 Elbow

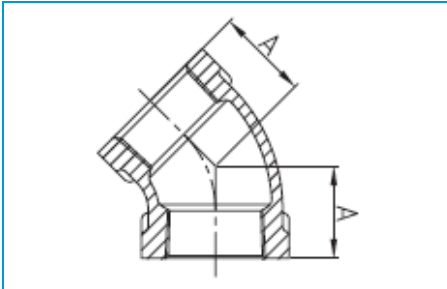

Size	1/8	1/4	3/8	1/2	3/4	1
A	0.63	0.73	0.80	0.88	0.98	1.12
Size	1-1/4	1-1/2	2	2-1/2	3	4
A	1.29	1.43	1.68	1.95	2.17	2.61
Size	5	6				
A	3.05	3.46				

90 Street Elbow

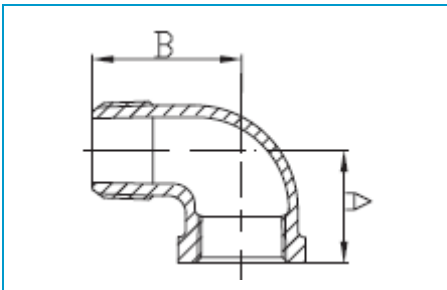

Size	1/8	1/4	3/8	1/2	3/4	1
A	0.69	0.81	0.95	1.12	1.31	1.50
B	1.00	1.19	1.44	1.62	1.89	2.14
Size	1-1/4	1-1/2	2	2-1/2	3	4
A	1.75	1.94	2.25	2.70	3.08	3.79
B	2.45	2.69	3.26	3.86	4.52	5.69

45 Street Elbow

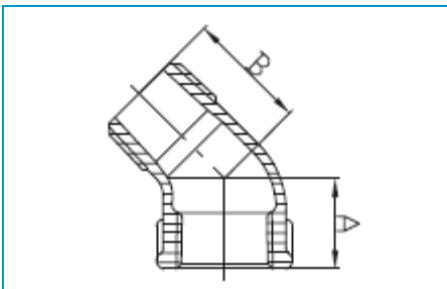

Size	1/8	1/4	3/8	1/2	3/4	1
A	0.63	0.73	0.80	0.88	0.98	1.12
B	0.83	0.94	1.03	1.15	1.29	1.47
Size	1-1/4	1-1/2	2	2-1/2	3	4
A	1.29	1.43	1.68	1.95	2.17	2.61
B	1.71	1.88	2.22	2.57	3.00	3.70

CHINA

150# Malleable Fittings

Specification Sheet

Reducing Elbow

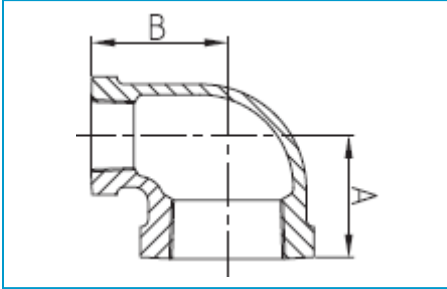

Size	1/4x1/8	3/8x1/8	3/8x1/4	1/2x1/4	1/2x3/8	3/4x1/4	3/4x3/8	3/4x1/2
A	0.74	0.81	0.88	0.97	1.04	1.05	1.12	1.20
B	0.76	0.85	0.90	0.98	1.03	1.08	1.13	1.22
Size	1x1/2	1x3/4	1-1/4x1/2	1-1/4x3/4	1-1/4x1	1-1/2x1/2	1-1/2x3/4	1-1/2x1
A	1.26	1.37	1.34	1.45	1.58	1.38	1.52	1.65
B	1.40	1.45	1.53	1.62	1.67	1.64	1.75	1.80
Size	1-1/2x1-1/4	2x1/2	2x3/4	2x1	2x1-1/4	2x1-1/2	2-1/2x1-1/4	
A	1.82	1.48	1.60	1.73	1.90	2.02	1.99	
B	1.88	1.87	1.97	2.02	2.10	2.16	2.36	
Size	2-1/2x1-1/2	2-1/2x2	3x1-1/2	3x2	3x2-1/2	4x2	4x3	
A	2.16	2.39	2.29	2.52	2.83	2.72	3.30	
B	2.51	2.60	2.84	2.89	2.99	3.43	3.60	

Side Outlet Elbow

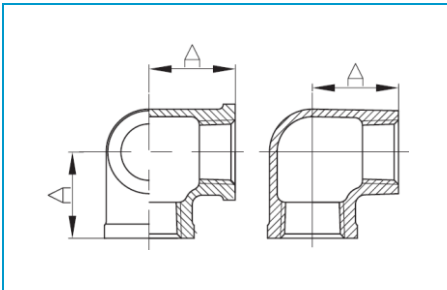

Size	1/2	3/4
A	1.10	1.30

Tee

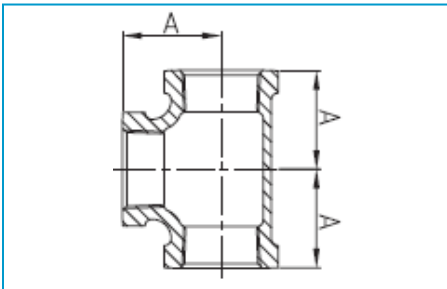

Size	1/8	1/4	3/8	1/2	3/4	1
A	0.69	0.81	0.95	1.12	1.31	1.50
Size	1-1/4	1-1/2	2	2-1/2	3	4
A	1.75	1.94	2.25	2.70	3.08	3.79
Size	5	6				
A	4.50	5.13				

Street Service Tee

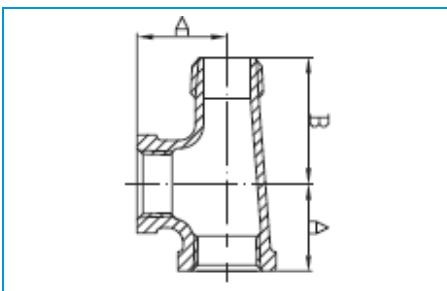

Size	1/2	3/4	1
A	1.12	1.31	1.50
B	1.62	1.89	2.14

CHINA

150# Malleable Fittings Specification Sheet

Reducing Tee

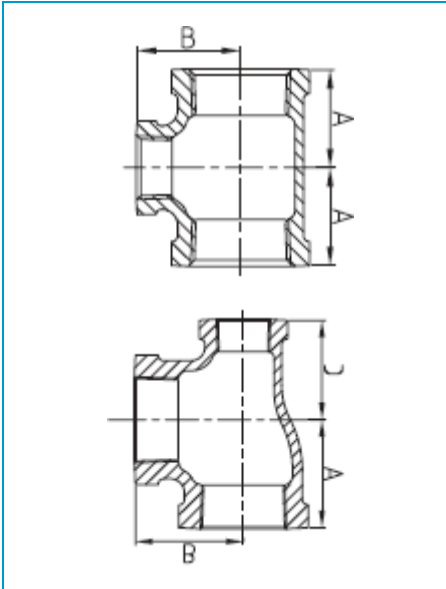

Size	1/2x1/4	1/2x3/8	3/4x1/4	3/4x3/8	3/4x1/2	1x1/4	1x3/8	1x1/2	1x3/4
A	0.97	1.04	1.05	1.12	1.20	1.11	1.18	1.26	1.37
B	0.98	1.03	1.08	1.13	1.22	1.22	1.28	1.40	1.45
Size	1-1/4x1/2	1-1/4x3/4	1-1/4x1	1-1/2x1/2	1-1/2x3/4	1-1/2x1-1/4	2x1/2	2x3/4	
A	1.34	1.45	1.58	1.41	1.52	1.82	1.49	1.60	
B	1.53	1.62	1.67	1.66	1.75	1.88	1.88	1.97	
Size	2x1	2x1-1/4	2x1-1/2	2-1/2x1/2	2-1/2x3/4	2-1/2x1	2-1/2x1-1/2		
A	1.73	1.90	2.02	1.62	1.74	1.87	2.16		
B	2.02	2.10	2.16	2.25	2.32	2.37	2.51		
Size	2-1/2x2	3x1	3x1-1/4	3x1-1/2	3x2	3x2-1/2	4x2	4x2-1/2	4x3
A	2.39	2.00	2.17	2.29	2.52	2.83	2.74	3.05	3.30
B	2.60	2.66	2.74	2.80	2.89	2.99	3.41	3.51	3.60
Size	1/2x1/4x1/2	3/4x1/2x1/2	3/4x1/2x3/4	3/4x1/2x1	1x1/4x1	1x1/2x1/2	1x1/2x3/4	1x1/2x1	
A	1.12	1.20	1.31	1.50	1.46	1.26	1.37	1.50	
B	1.12	1.22	1.31	1.34	1.46	1.40	1.45	1.50	
C	0.98	1.12	1.22	1.30	1.18	1.12	1.22	1.40	

Size	1x3/4x3/4	1x3/4x1	1-1/4x1/2x1/2	1-1/4x1/2x3/4	1-1/4x1/2x1-1/4	1-1/4x3/4x1/2	1-1/4x3/4x3/4	1-1/4x3/4x1	1-1/4x3/4x1-1/4	1-1/4x1x1/2
A	1.37	1.50	1.34	1.38	1.75	1.58	1.45	1.58	1.75	1.34
B	1.45	1.50	1.50	1.50	1.75	1.67	1.62	1.67	1.75	1.53
C	1.31	1.45	1.06	1.14	1.53	1.46	1.31	1.45	1.62	1.26

Size	1-1/4x1x3/4	1-1/4x1x1	1-1/4x1x1-1/4	1-1/2x1/2x1	1-1/2x1/2x1-1/2	1-1/2x3/4x3/4	1-1/2x3/4x1	1-1/2x3/4x1-1/4	1-1/2x3/4x1-1/2	1-1/2x1x1
A	1.45	1.58	1.75	1.73	1.94	1.50	1.73	1.81	1.94	1.65
B	1.62	1.67	1.75	1.81	1.94	1.69	1.81	1.89	1.94	1.80
C	1.37	1.50	1.67	1.34	1.66	1.26	1.38	1.62	1.75	1.50

Size	1-1/2x1x1-1/2	1-1/2x1-1/4x1/2	1-1/2x1-1/4x3/4	1-1/2x1-1/4x1	1-1/2x1-1/4x1-1/4	1-1/2x1-1/4x1-1/2	2x1/2x2	2x3/4x2	2x1x1
A	1.94	1.41	1.52	1.65	1.82	1.94	2.25	2.25	1.73
B	1.94	1.66	1.75	1.80	1.88	1.94	2.25	2.25	2.01
C	1.80	1.34	1.43	1.58	1.75	1.88	1.88	1.97	1.50

Size	2x1x1-1/2	2x1x2	2x1-1/4x1	2x1-1/4x1-1/4	2x1-1/4x1-1/2	2x1-1/4x2	2x1-1/2x3/4	2x1-1/2x1	2x1-1/2x1-1/4	2x1-1/2x1-1/2	2x1-1/2x2
A	2.02	2.25	1.58	1.90	2.02	2.25	1.56	1.73	1.90	2.02	2.25
B	2.16	2.25	2.01	2.10	2.16	2.25	1.93	2.02	2.10	2.16	2.25
C	1.80	2.02	1.73	1.75	1.88	2.10	1.48	1.65	1.82	1.94	2.16

Side Outlet Tee

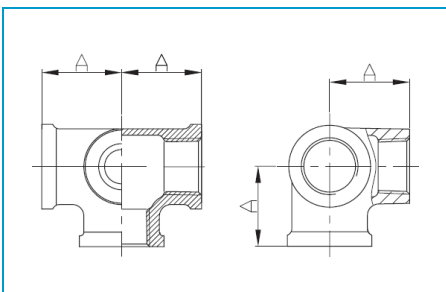

Size	1/2	3/4
A	1.10	1.30

CHINA

150# Malleable Fittings

Specification Sheet

Bull Head Tee

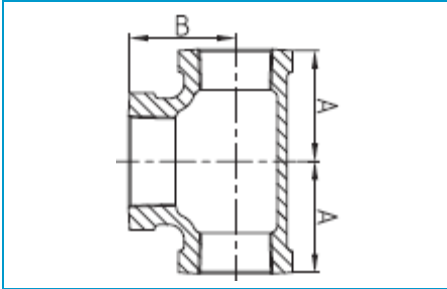

Size	1/2x1/2x3/4	1/2x1/2x1	3/4x3/4x1	1x1x1-1/4	1x1x1-1/2
A	1.22	1.36	1.45	1.67	1.80
B	1.20	1.26	1.37	1.58	1.65

Size	1x1x2	1-1/4x1-1/4x1-1/2	1-1/2x1-1/2x2	2x2x2-1/2
A	2.02	1.88	2.16	2.60
B	1.93	1.82	2.02	2.39

Square Head Plug

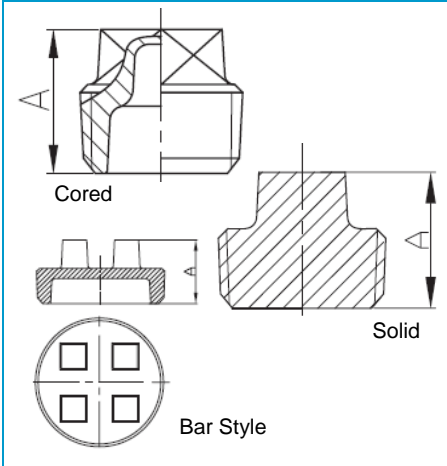

Size	1/8	1/4	3/8	1/2	1/2 (Solid)	3/4
A	0.61	0.72	0.79	0.94	0.94	1.07

Size	1	1-1/4	1-1/2	2	2-1/2	3
A	1.23	1.36	1.45	1.56	1.81	1.93

Size	4	4 (Bar Style)	6	6 (Bar Style)
A	2.54	2.22	2.82	2.66

Square Countersunk Plug

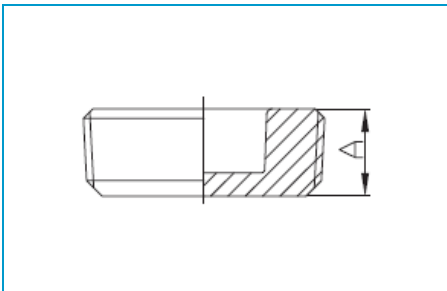

Size	1	1-1/2	2
A	0.75	0.83	0.88

Cross

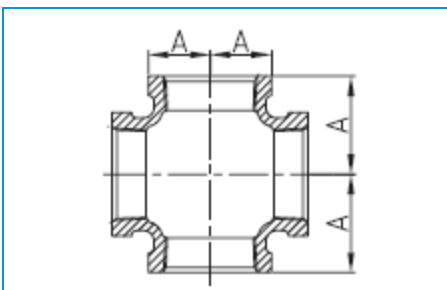

Size	1/4	3/8	1/2	3/4	1
A	0.81	0.95	1.12	1.31	1.50

Size	1-1/4	1-1/2	2	2-1/2
A	1.75	1.94	2.25	2.70

CHINA

150# Malleable Fittings

Specification Sheet

Extension Piece

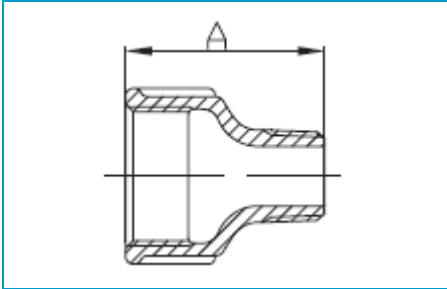

Size	1/2	3/4
A	1.69	1.89

Floor Flange

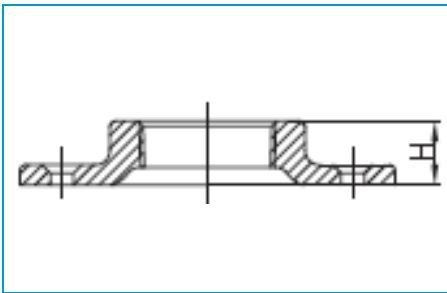

Size	1/4	3/8	1/2	3/4	1
H	0.47	0.55	0.55	0.63	0.67
Size	1-1/4	1-1/2	2		
H	0.75	0.87	0.99		

Union

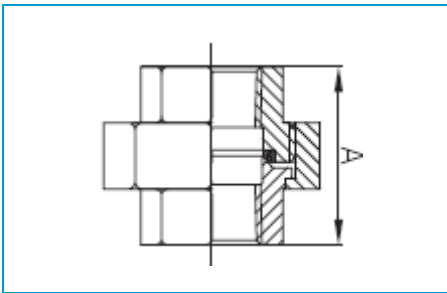

Size	1/8	1/4	3/8	1/2	3/4	1
A	1.26	1.44	1.62	1.71	1.95	2.07
Size	1-1/4	1-1/2	2	2-1/2	3	4
A	2.27	2.40	2.76	3.23	3.51	3.86

Cap

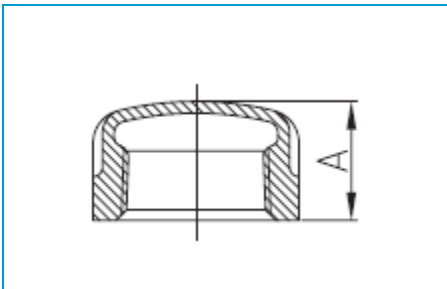

Size	1/8	1/4	3/8	1/2	3/4	1	1-1/4
A	0.53	0.63	0.74	0.87	0.97	1.16	1.28
Size	1-1/2	2	2-1/2	3	4	5	6
A	1.33	1.45	1.70	1.80	2.08	2.32	2.55

CHINA

150# Malleable Fittings

Specification Sheet

Coupling

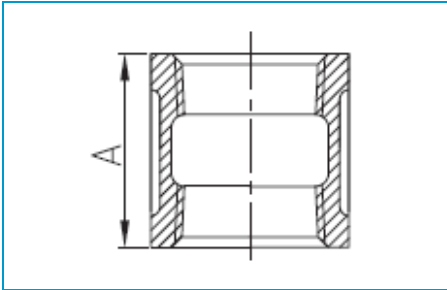

Size	1/8	1/4	3/8	1/2	3/4	1	1-1/4
A	0.95	1.06	1.16	1.34	1.54	1.67	1.93
Size	1-1/2	2	2-1/2	3	4	5	6
A	2.15	2.53	2.88	3.18	3.69	3.74	4.14

Reducing Coupling

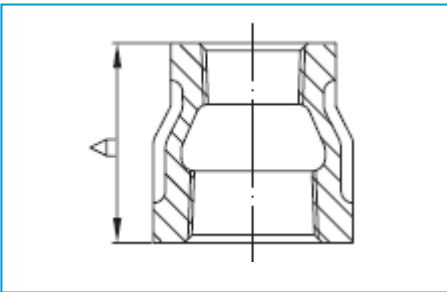

Size	1/4x1/8	3/8x1/8	3/8x1/4	1/2x1/8	1/2x1/4	1/2x3/8	3/4x1/8
A	1.00	1.13	1.13	1.25	1.25	1.25	1.44
Size	3/4x1/4	3/4x3/8	3/4x1/2	1x1/4	1x3/8	1x1/2	1x3/4
A	1.44	1.44	1.44	1.69	1.69	1.69	1.69
Size	1-1/4x3/8	1-1/4x1/2	1-1/4x3/4	1-1/4x1	1-1/2x3/8	1-1/2x1/2	1-1/2x3/4
A	2.06	2.06	2.06	2.06	2.31	2.31	2.31
Size	1-1/2x1	1-1/2x1-1/4	2x3/8	2x1/2	2x3/4	2x1	2x1-1/4
A	2.31	2.31	2.81	2.81	2.81	2.81	2.81
Size	2x1-1/2	2-1/2x1/2	2-1/2x3/4	2-1/2x1	2-1/2x1-1/4	2-1/2x1-1/2	
A	2.81	3.25	3.25	3.25	3.25	3.25	
Size	2-1/2x2	3x1/2	3x3/4	3x1	3x1-1/4	3x1-1/2	3x2
A	3.25	3.69	3.69	3.69	3.69	3.69	3.69
Size	3x2-1/2	4x1-1/2	4x2	4x2-1/2	4x3		
A	3.69	4.39	4.39	4.39	4.39		

Right & Left Coupling

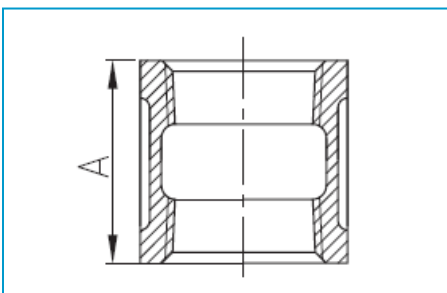

Size	1/2	3/4	1	1-1/4	1-1/2	2
A	1.34	1.52	1.67	1.93	2.15	2.53
Size	2-1/2	3	4			
A	2.88	3.18	3.69			

CHINA

150# Malleable Fittings

Specification Sheet

Outside Hex Bushing

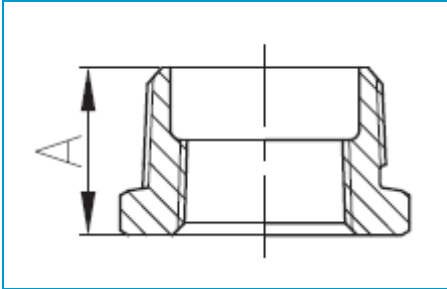

Size	1/4x1/8	3/8x1/8	3/8x1/4	1/2x1/8	1/2x1/4	1/2x3/8	3/4x1/8
A	0.58	0.64	0.64	0.75	0.75	0.75	0.85
Size	3/4x1/4	3/4x3/8	3/4x1/2	1x1/2	1x3/4	1-1/4x3/4	1-1/4x1
A	0.85	0.85	0.85	1.00	1.00	1.08	1.08
Size	1-1/2x1	1-1/2x1-1/4	2x1-1/4	2x1-1/2	2-1/2x1-1/2	2-1/2x2	
A	1.14	1.14	1.22	1.22	1.51	1.44	
Size	3x2	3x2-1/2	4x3	5x4	6x5		
A	1.61	1.53	1.72	1.81	2.03		

Inside Hex Bushing

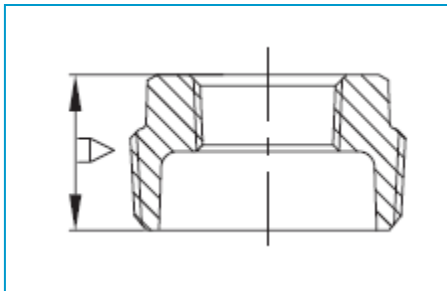

Size	1x1/8	1x1/4	1x3/8	1-1/4x3/8	1-1/4x1/2	1-1/2x1/4	1-1/2x3/8	
A	1.05	1.05	1.05	1.14	1.14	1.20	1.20	
Size	1-1/2x1/2	1-1/2x3/4	2x1/4	2x3/8	2x1/2	2x3/4	2x1	
A	1.20	1.20	1.29	1.29	1.29	1.29	1.29	
Size	2-1/2x1/2	2-1/2x3/4	2-1/2x1/2	2-1/2x3/4	3x1	3x1-1/4	3x1-1/2	
A	1.51	1.51	1.51	1.51	1.61	1.61	1.61	
Size	4x1	4x1-1/4	4x1-1/2	4x2	4x2-1/2	6x2	6x3	6x4
A	1.82	1.82	1.82	1.82	1.82	2.16	2.16	2.16

Locknut

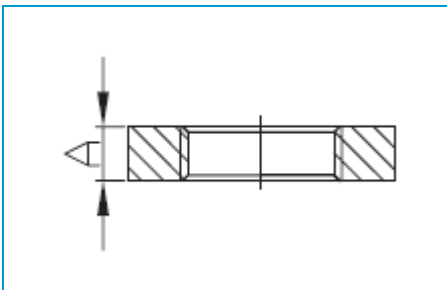

Size	1/2	3/4	1	1-1/4	1-1/2	2
A	0.31	0.34	0.38	0.42	0.47	0.53

MATCO
NORCA